

# CERTIFICATE

Certified Passive House Component

Component-ID 0605wi03 valid until 31st December 2026

Passive House Institute  
Dr. Wolfgang Feist  
64283 Darmstadt  
Germany

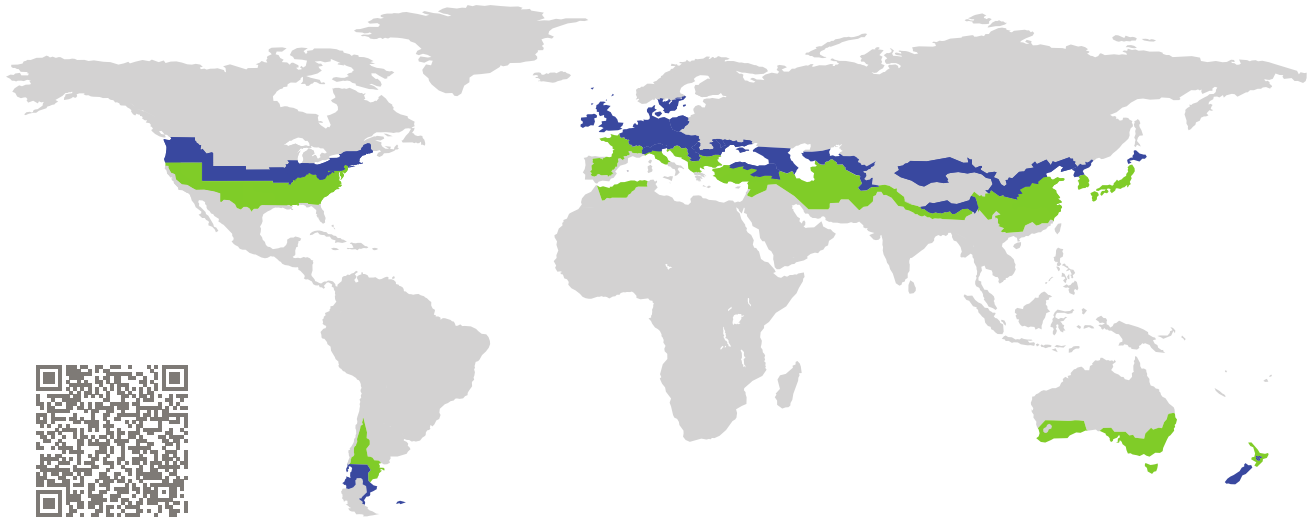

Category: **Window Frame**  
Manufacturer: **Aluprof S.A.,  
Bielsko-Biala,  
Poland**  
Product name: **MB-104 Passive SI**

**This certificate was awarded based on the following  
criteria for the cool, temperate climate zone**

Comfort  $U_W = 0.80 \leq 0.80 \text{ W}/(\text{m}^2 \text{ K})$   
 $U_{W, \text{installed}} \leq 0.85 \text{ W}/(\text{m}^2 \text{ K})$   
with  $U_g = 0.70 \text{ W}/(\text{m}^2 \text{ K})$

Hygiene  $f_{Rsi=0.25} \geq 0.70$

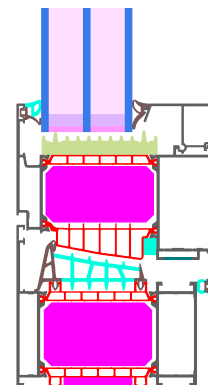

Passive House  
efficiency class

phE

phD

phC

phB

phA

[www.passivehouse.com](http://www.passivehouse.com)

cool, temperate climate



**CERTIFIED  
COMPONENT**

Passive House Institute

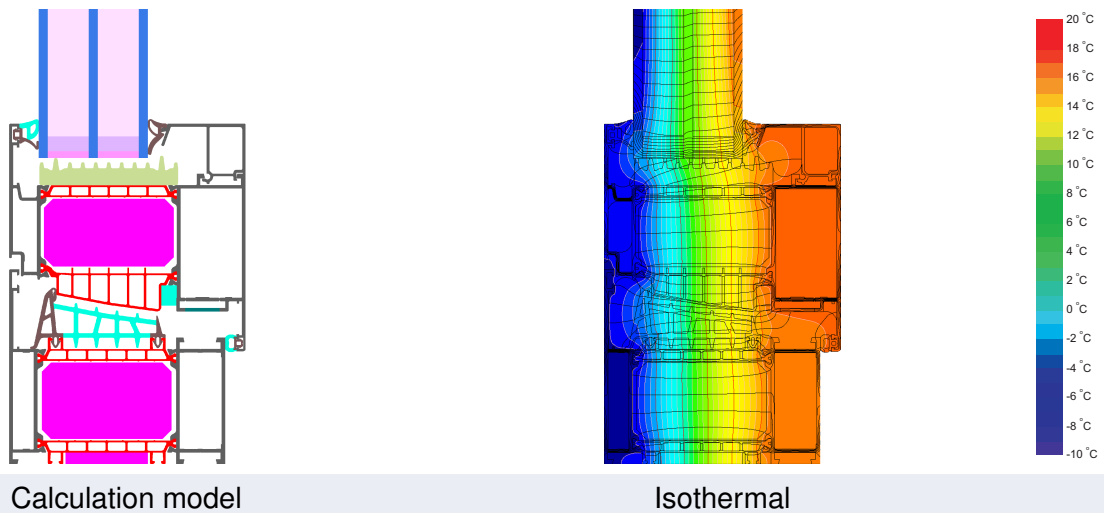

Calculation model Isothermal

**Description**

Aluminium frame with insulationcore made of expanded polystyrene and rebate insulation of polyethylene foam. Pane thickness: 48 mm (4/18/4/18/4), Rebate depth: 15 mm.

**Explanation**





The window U-values were calculated for the test window size of 1.23 m × 1.48 m with  $U_g = 0.70 \text{ W}/(\text{m}^2 \text{ K})$ . If a higher quality glazing is used, the window U-values will improve as follows:

Glazing	$U_g =$	0.70	0.64	0.58	0.54	$\text{W}/(\text{m}^2 \text{ K})$
		↓	↓	↓	↓	
Window	$U_W =$	0.80	0.76	0.73	0.70	$\text{W}/(\text{m}^2 \text{ K})$

Transparent building components are classified into efficiency classes depending on the heat losses through the opaque part. The frame U-Values, frame widths, thermal bridges at the glazing edge, and the glazing edge lengths are included in these heat losses. A more detailed report of the calculations performed in the context of certification is available from the manufacturer.

The Passive House Institute has defined international component criteria for seven climate zones. In principle, components which have been certified for climate zones with higher requirements may also be used in climates with less stringent requirements. In a particular climate zone it may make sense to use a component of a higher thermal quality which has been certified for a climate zone with more stringent requirements.

Further information relating to certification can be found on [www.passivehouse.com](http://www.passivehouse.com) and [passipedia.org](http://passipedia.org).

Frame values		Frame width $b_f$ mm	$U$ -value frame $U_f$ W/(m <sup>2</sup> K)	$\Psi$ -glazing edge $\Psi_g$ W/(m K)	Temp. Factor $f_{RSI=0.25}$ [-]
Flying Mullion	(FM1) 	182	0.77	0.020	0.77
Bottom	(OB1) 	150	0.83	0.021	0.77
Head	(OH1) 	150	0.83	0.021	0.77
Jamb	(OJ1) 	150	0.83	0.021	0.77
		Spacer: SWISSPACER Ultimate		Secondary seal: Polysulfide	

### Validated installations

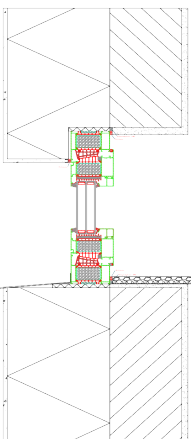
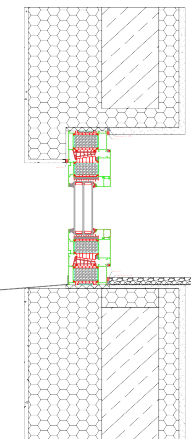
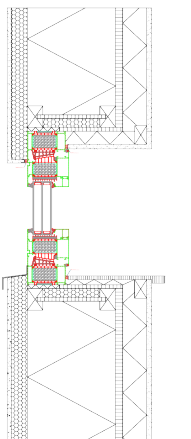
Exterior insulation and finishing system (EIFS) (operable)		Formwork blocks (operable)		Lightweight timber (operable)	
					
$\Psi_{install}$	W/(m K)	$\Psi_{install}$	W/(m K)	$\Psi_{install}$	W/(m K)
Top	0.011	Top	0.010	Top	0.015
Side	0.011	Side	0.010	Side	0.015
Bottom	0.029	Bottom	0.022	Bottom	0.029
$U_{W,installed} = 0.85$ W/(m <sup>2</sup> K)		$U_{W,installed} = 0.84$ W/(m <sup>2</sup> K)		$U_{W,installed} = 0.85$ W/(m <sup>2</sup> K)	

Disclaimer: The Passive House Institute GmbH (PHI) conducts heat-transfer analyses in accordance with the standards set out in Criteria and Algorithms for Certified Passive House Components: Transparent Building Components and Opening Elements in the Building Envelope, based on information provided by the manufacturer. PHI does not verify on-site implementation. It is the responsibility of the project leader to ensure that installed components match the certified specifications in terms of geometry, configuration, and materials. Manufacturers must make full product information available upon request to parties involved in a construction project. These parties may compare the provided information with project documentation and perform on-site inspections as part of the quality-assurance process.

